

Coin Box

EMS-8x-S0

Operating Manual

(Version for sunbeds)



www.tgelectronics.no

Vidhaugen 114
7550 Hommelvik
Tele:73979017-91795392
e-post: post@tgelectronics.no



www.tgelectronics.no

Vidhaugen 114
7550 Hommelvik
Tele: 73979017-91795392
e-post: post@tgelectronics.no

All rights reserved. No part of this manual may be reproduced or copied in any way without authorization of the Beckmann GmbH.

The Beckmann GmbH is not liable to the buyer or other persons for damages, losses, costs or expenses, that are caused by the buyer or other persons by accident, misuse, unauthorized changes, repair or innovations of the product. Furthermore the Beckmann GmbH is not liable for losses, costs, faults or consequential losses, that may emerge by using this product. The technical data correspond to the current conditions. Misprints, errors or changes reserved.

Beckmann GmbH
Brandtstraße 1
33161 Hövelhof
Fon +49 (0) 52 57 - 98 23 - 0
Fax +49 (0) 52 57 - 98 23 - 11
info@beckmann-gmbh.de
www.beckmann-gmbh.de

Table of contents

1 Equipment features.....	4
2 Safety precautions.....	4
3 Installation and maintenance.....	5
3.1 Mounting.....	5
3.2 Electrical installation.....	6
3.3 Maintenance.....	6
4 Operation.....	7
4.1 Time selling.....	7
5 Programming.....	8
5.1 Procedure.....	8
5.2 Counter editing.....	8
5.3 Adjusting operating parameters.....	8
5.4 Switch-parameter.....	9
5.5 Parameter overview EMS-8x-SO.....	9
6 Other.....	11
6.1 Switching on.....	11
6.2 Factory default settings.....	11
6.3 Readout serial number.....	11
7 Technical data.....	11

List of figures

Figure 1 : Dimensions.....	5
Figure 2 : Connection diagram.....	6
Figure 3 : Display.....	7
Figure 4 : Counter display for larger values.....	8

List of tables

Table 1 : Parameterlist.....	9
------------------------------	---



www.tgelectronics.no

Vidhaugen 114
 7550 Hommelvik
 Tele:73979017-91795392
 e-post: post@tgelectronics.no

1 Equipment features

General features of EMS-8x series

- 16 Bit processor controlled
- electronic coin selector for five different types of coins + one free adjustable token
- 3-digit LED-display
- programming via keyboard
- programmable minimum insertion
- programmable maximum time
- additional coin insertion during operation possible
- several electronic cash counters
- two electronic hour meters (one erasable)
- door opener for washing machines or dryers
- simple software update via optional SD-Card adapter

Special features of EMS-8x-SO

- delay adjustable
- remote start function
- fan off delay
- cooling time selectable
- customer counter
- cleaning mode
- safety circuit EN 60335-2-27/A11

2 Safety precautions

The coin operated timers of the EMS-8x series are built by the state of technology and the generally accepted safety-related rules. Nevertheless there may occur risks for the user or other persons as well as impairments of the device or other values. Use the device only under faultless conditions, as well as due, safety- and risk-conscious regarding the user manual! Especially eliminate faults, that may impair safety, immediately! Keep the user manual always on site of the device! Pay attention - additional to the user manual - to the general valid legal and other obligatory rules such as accident prevention and environmental protection! Do not make any changes and / or modifications without the authorization of the manufacturer. Spare parts have to correspond to the manufacturer-defined standards. This is only guaranteed, if original spare parts are used. Maintain the required or within this manual stated deadlines for repeating maintenance intervals! Provide a safe and non-polluting disposal of plastic or electrical replacement parts!

This coin operated timers are exclusive designed for managing different electric devices in rooms. Any other or further use is not provided. The manufacturer is not liable for losses, that result from misuse. A due use contains to heed the user guide and to observe the terms of service and maintenance as well.

3 Installation and maintenance

3.1 Mounting

The unit is provided for fixed wiring and assembly in rooms. For fixing the device there are 3 drillings with a diameter of 6 mm at the back side. It must be taken care that the case is mounted vertically, because otherwise the functioning of the coin selector may be reduced. The EMS-8x should be mounted at a solid wall in order to avoid heavy vibrations.

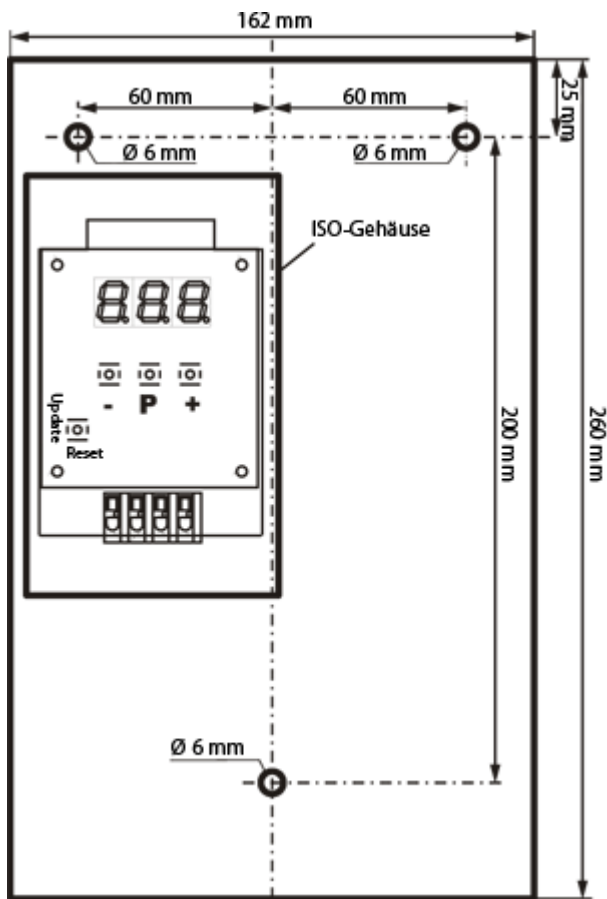

Figure 1 : Dimensions



www.tgelectronics.no

Vidhaugen 114
7550 Hommelvik
Tele: 73979017-91795392
e-post: post@tgelectronics.no

3.2 Electrical installation

CAUTION:

The installation has to be effected by authorized staff only! Please arrange that the assembly is carried out by a specialist electronic company. Since this is a stationary device with line-side fixed connection, a circuit breaker must be installed on the installation side!

The installation of the EMS-8x is limited to the connection of the mains and the switched output according to the connection survey installed in the device.

Note that all wires are fitting exactly into the ISO box.

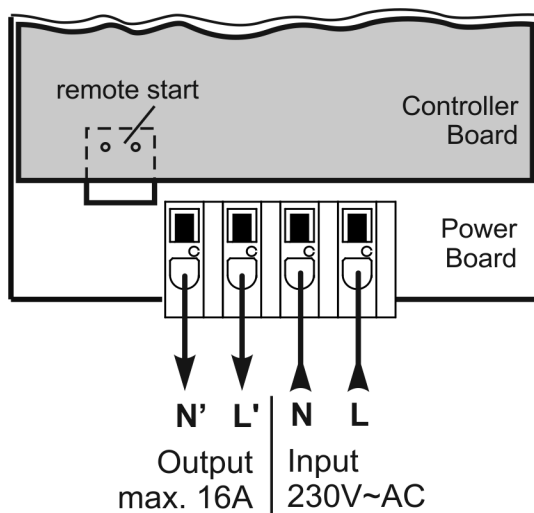

Figure 2 : Connection diagram

3.3 Maintenance

The devices of the EMS-8x series are nearly maintenance-free. Only the coin selector has to be cleaned sometimes, in order to guarantee a proper operation.



www.tgelectronics.no

Vidhaugen 114
 7550 Hommelvik
 Tele: 73979017-91795392
 e-post: post@tgelectronics.no

4 Operation

After final programming a time sale can be effected with the EMS-8x. The following description refers to factory default programming of the EMS-8x.

4.1 Time selling

The EMS-8x has a 3-digit LED-Display, that shows the customer the current state of the device. A survey you can find in the following figure.







	<p>Display shows „0“: The connected device is free. Coins can be inserted.</p>
	<p>Time is flashing : Coins have been inserted an the minimum insertion has not be achieved yet. Further coins must be inserted.</p>
	<p>Time is displayed : Coins have been inserted. The device can be started. Further coins can be inserted.</p>
	<p>Time is displayed and the decimal point is flashing The device is in operation for the indicated (remaining) time.</p>
	<p>Display shows „L-“ und a time The ventilation is still running for the indicated (remaining) time. Coins cannot be inserted.</p>
	<p>Display shows „-P-“ The device is in cleaning mode. Coins cannot be inserted.</p>

Figure 3 : Display

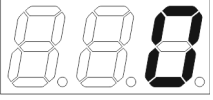
Before starting the payment, the device must be free, i.e. the display must show "0". After insertion of the first coin, the EMS-8x indicates the released time. As far as the minimum insertion is not achieved, the time is indicated flashing. When the min. insertion is achieved by inserting a further coin, the display does not flash any more and the device starts. If further coins are inserted, the currently released time is indicated. If the maximum time is achieved, the coin selector will be blocked and additional coins can not be inserted anymore.

While the time runs down, the decimal point will blink and the displayed time will decrease by one every minute that expires. During the last minute the display changes and the remaining seconds are displayed. After the time has run out completely the display shows „0“ and the output shuts off.

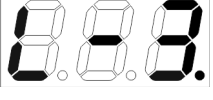
5 Programming

5.1 Procedure

For the programming of the EMS-8x, the device has to be opened. At the control board inside of the ISO box there are three buttons available.

By pressing the "P" button you will enter the programming mode which is indicated in the display by "Pro". This state can be left by pushing the "+" button. During runtime an emergency stop can be performed by pushing the "-" button. An emergency stop will reset the device to "free" state

By pressing the "P" button another time you are in the parameter edit mode. The display shows alternating a "P", followed by the parameter number and the value of the respective parameter. Press the "P" button several times until you reach the required parameter. You can find a listing of all parameters in Table 1, section 5.5. By pressing the "P" button another time if the last parameter is reached, all settings are stored and the EMS-8x is in "free" state again. All parameters are stored electronically and do not lose their values even if the device is switched off. If no button is pressed for a period of at least 30 seconds, all settings are stored automatically and the EMS-8x changes over to "free" state.

In the following sections the 3 types of parameters, counter, operating values and switches, are described.

5.2 Counter editing

Counters are cash counters, customer counters or hour meters. There are erasable and non-erasable counters. The erasable counters can be erased by pressing the "+" or "-" button.

Some counters have a range higher than 999. As the display has only 3-digits, the notation is segmented on values higher than 999. The display changes between the parameter-number, the high level digits (digits 4 - 5) and the low level digits (digits 1 - 3). The high level digits are indicated by the flashing decimal point at the right side. In Figure 4 you can see an example for the counter operating hours 1 with a counter value of 21 740 hours. If the value is lower than 1.000 the display changes only between the parameter number and the low level digit display.



Figure 4 : Counter display for larger values

5.3 Adjusting operating parameters

Operating parameters are values, you can adjust the prices or the maximum time with. These values can be increased by pressing the button "+" and decreased by pressing the button "-". The rate is either 1 or 0,1 depending on the parameter. On pressing the "+" resp. "-" button for a longer time, the value can be changed faster.

5.4 Switch-parameter

By means of the switches a function can be switched on or off. These parameters have two options only, which can be changed by pressing the "+" or "-" button.

5.5 Parameter overview EMS-8x-SO

Table 1 : Parameterlist

No		Parameter name/Parameter explanation	Typ	Range
P01	EMS-81	Cash Counter 1 Counter is increased with each Coin (amount of coins).	Counter	0 to 99.999
	EMS-82	Cash Counter 1 Counter is increased with the value of each Coin (and value of Token if P28 is ON)	Counter	0 to 99.999,99
P02	EMS-81	Cash Counter 2 (not erasable) counts as P01	Counter	0 to 99.999
	EMS-82	Cash Counter 2 (not erasable) counts as P01	Counter	0 to 99.999,99
P03	EMS-82	Token Counter 1 Counter is increased with each Token.	Counter	0 to 99.999
P04	EMS-82	Token Counter 2 (not erasable) counts as P03	Counter	0 to 99.999
P05		Customer Counter 1 Counter is increased on each device start.	Counter	0 to 49.999
P06		Customer Counter 2 (not erasable) counts as P05	Counter	0 to 49.999
P10		Operating Hours 1 Operation Hours in hours and minutes	Counter	0 to 99.999:59
P11		Operating Hours 2 (not erasable) as P10	Counter	0 to 99.999:59
P20	EMS-81	Minimum Insertion Indicates the amount of coins, that has to be inserted at least.	Operat.	1 to 100
	EMS-82	Minimum Insertion Indicates the amount of money, that has to be inserted at least.	Operat.	0,01 to 599,99
P21		Time release Indicates, how many minutes the device permits on minimum insertion.	Operat.	0:01 to 999:59
P22		Maximum Time Indicates the maximum time, that can be sold per operation in minutes and seconds (EMS-81 does not count coins after max. time is reached; EMS-82 will block coins).	Operat.	0:01 to 999:59
P23		Switch-on delay Indicates the delay time (minutes), that passes until the device starts automatically.	Operat.	0 bis 99
P24		Prolonged ventilation Indicates the time (minutes), the ventilation is running after the device has switched off.	Operat.	0 bis 99

No	Parameter name/Parameter explanation	Typ	Range
P25	Remote start enabled If this parameter is "ON", the delayed start can be stopped by the remote start button, so that the device starts immediately. If this parameter is set to "OFF", the remote start button has no function.	Switch	On / Off
P26	Cleaning mode Ist der Parameter „An“, wird das Gerät erst wieder frei gegeben, wenn die Reinigung mit der Fernstarttaste quittiert wurde. Ist der Parameter „AUS“, wird das Gerät sofort frei gegeben.	Switch	On / Off
P27	Pay additionally If ON, additional payment is allowed during runtime until max time is reached.	Switch	On / Off
P28	Count Token as Cash If ON, the Token Value (P29) is added to cash counter P01 and P02	Switch	On / Off
P29	Token Value Determines the value of one single token.	Operat.	0,01 to 599,99
P30	Test Mode Test Mode of device can be started.	Switch	Start/Stop
P31	In Operation If OFF, the device can be switched out of service (in case of failure).	Switch	On / Off
P32	Time Storage If ON, the remaining time will be saved in case of power failure, so that the time is continued after the power failure. If OFF, the device is free after a power failure.	Switch	On / Off



www.tgelectronics.no

Vidhaugen 114
7550 Hommelvik
Tele:73979017-91795392
e-post: post@tgelectronics.no

6 Other

6.1 Switching on

After switching on the machine, the letters "StA" (StArt) appear in the display for a few seconds which indicates the initialization of the machine. Then "LDP" appears, which means loading parameter list. Then the machine is ready for operation.

If "FLr" (Flash error) is displayed, an internal memory error of the machine occurred.

If the machine was turned off during a lapse of time and the P32 parameter was set to "on", the last saved full minute running time is restarted.

6.2 Factory default settings

To reset the machine with factory default settings, turn it off at first. Then keep the buttons "+" and "-" pressed simultaneously while switching on the machine.

"dFL" (default = basic settings) appears in the display.

6.3 Readout serial number

For service purposes or software updates, it is important to know the serial number of the device. The serial number is either visible on a sticker which is attached on the electronics or it can be readout by the software: Press and hold the "P" key during power up of the machine, then the 8-digit serial number will appear in couples (from left to right). The first digit of the couple indicates the position and the last the individual value.

Example:

Nr.: 00001564 The display shows in sequences:

„1-0“ -> „2-0“ -> „3-0“ -> „4-0“ -> „5-1“ -> „6-5“ -> „7-6“ -> „8-4“ -> Start

7 Technical data

Power source	230V AC/50Hz
Power consumption	5W
Max. switched power	max. 16A/230V
Operating temperature	0 bis 40 °C
Operating humidity	30 bis 70 %
Weight	3,5kg
Dimensions (B x H x T)	162 x 260 x 110 mm
Data retention in "off"-state	20 years



www.tgelectronics.no

Vidhaugen 114
7550 Hommelvik
Tele: 73979017-91795392
e-post: post@tgelectronics.no